



US006327301B1

(12) **United States Patent**
Demjanenko et al.

(10) **Patent No.:** **US 6,327,301 B1**
(45) **Date of Patent:** ***Dec. 4, 2001**

(54) **DETECTION AND ADAPTATION TO DIGITAL NETWORK IMPAIRMENTS BY PCM MODEMS**

(75) Inventors: **Victor Demjanenko**, Pendleton, NY (US); **Frederic J. Hirzel**, Sunnyvale, CA (US)

(73) Assignee: **Vocal Technologies, Ltd.**, Buffalo, NY (US)

(*) Notice: This patent issued on a continued prosecution application filed under 37 CFR 1.53(d), and is subject to the twenty year patent term provisions of 35 U.S.C. 154(a)(2).

Subject to any disclaimer, the term of this patent is extended or adjusted under 35 U.S.C. 154(b) by 0 days.

(21) Appl. No.: **09/033,821**

(22) Filed: **Mar. 3, 1998**

Related U.S. Application Data

(60) Provisional application No. 60/038,570, filed on Mar. 3, 1997.

(51) **Int. Cl.**⁷ **H04B 1/38; H04M 1/64**

(52) **U.S. Cl.** **375/222; 379/94**

(58) **Field of Search** **375/222, 225, 375/220, 242; 379/94, 97, 98; 370/385, 278, 282**

(56) **References Cited**

U.S. PATENT DOCUMENTS

5,663,982 * 9/1997 Hodge et al. 375/222
5,671,251 * 9/1997 Blackwell et al. 375/222
5,754,594 * 5/1998 Betts et al. 375/285

* cited by examiner

Primary Examiner—Chi Pham

Assistant Examiner—Khai Tran

(74) *Attorney, Agent, or Firm*—Foley & Lardner

(57) **ABSTRACT**

A method of compensating for systemic impairments in a telecommunications network is disclosed. The method may involve transmitting a candidate set of digital symbols from a digital modem to an analog modem, processing an analog representation of said candidate set of digital symbols in the analog modem, deriving a set of data information symbols from the analog representation of the candidate set of digital symbols, transmitting a representation of the data information symbols from the said analog modem to the digital modem, and using the representation of the data information symbols in digital modem for subsequent transmission of data from the digital modem. The method may also include the preceding steps of sending digital symbols from the digital modem to the analog modem, converting the digital symbols into analog signals in the telephone network, processing the analog signals in the analog modem, and training a receiver of the analog modem to recognize changes in the analog signals that correspond to known changes in digital symbols transmitted by the digital modem.

4 Claims, 7 Drawing Sheets

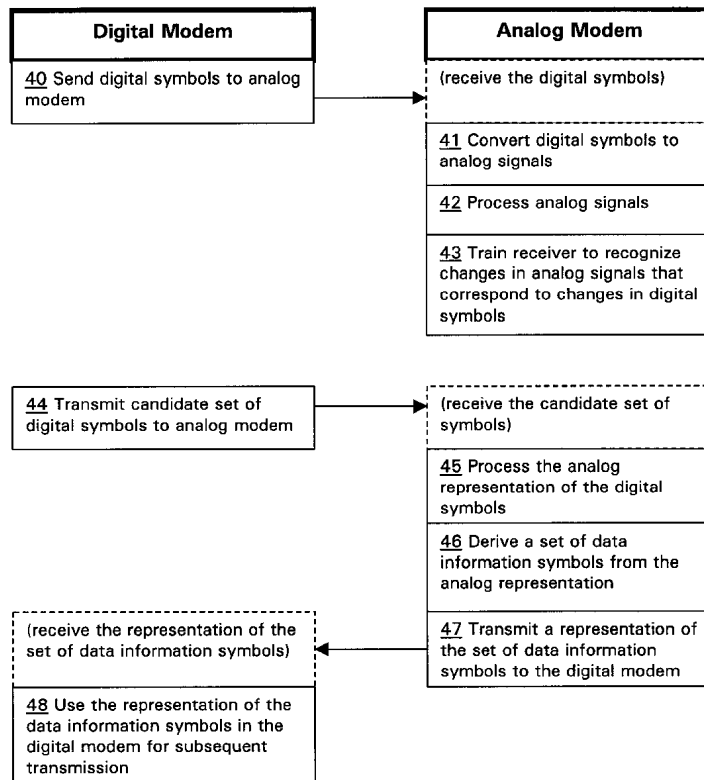

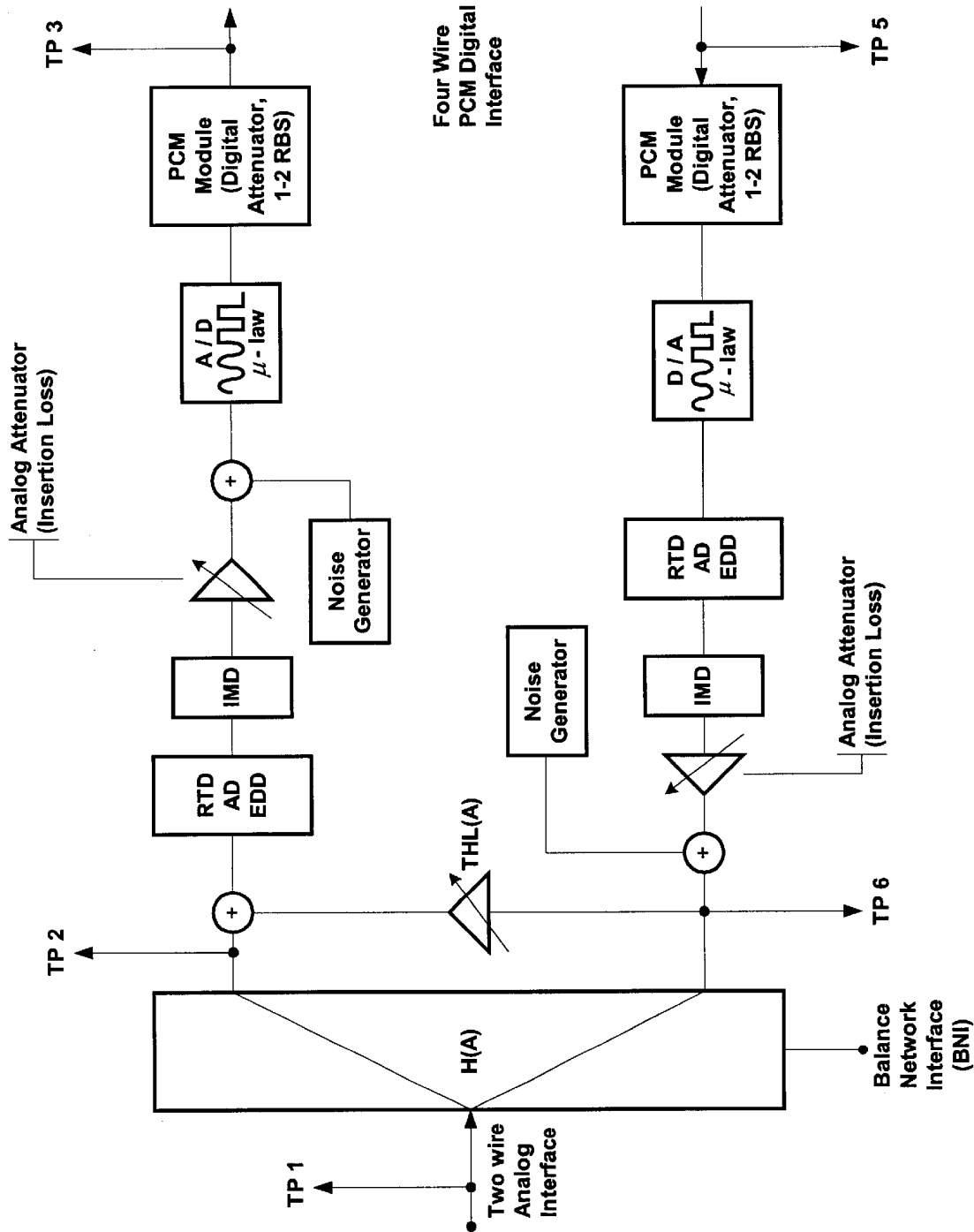

Figure 1 Prior Art

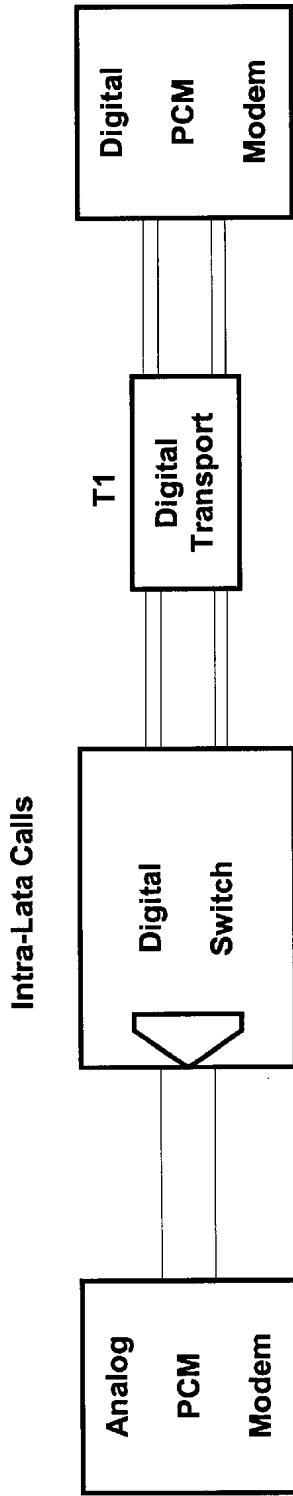

Figure 2A Prior Art

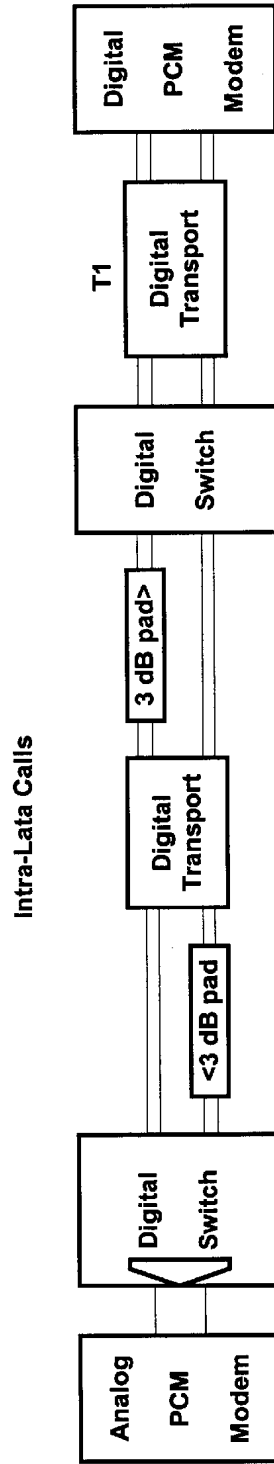

Figure 2B Prior Art

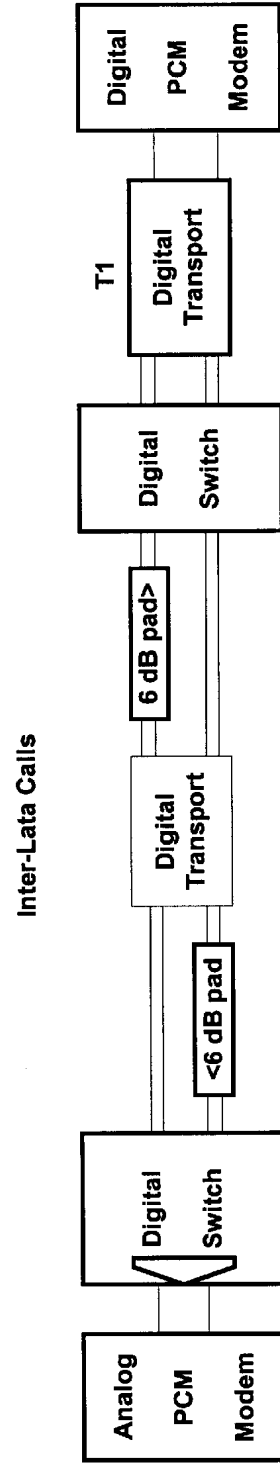

Figure 2C Prior Art

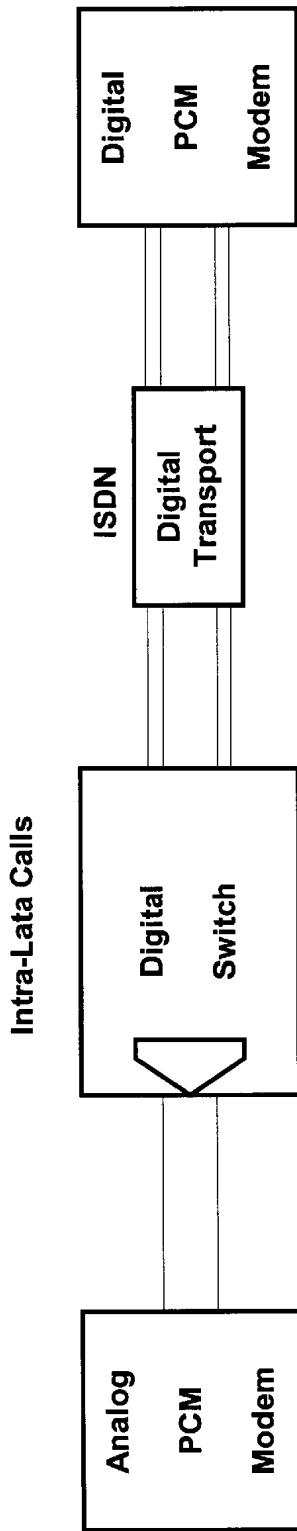

Figure 2D Prior Art

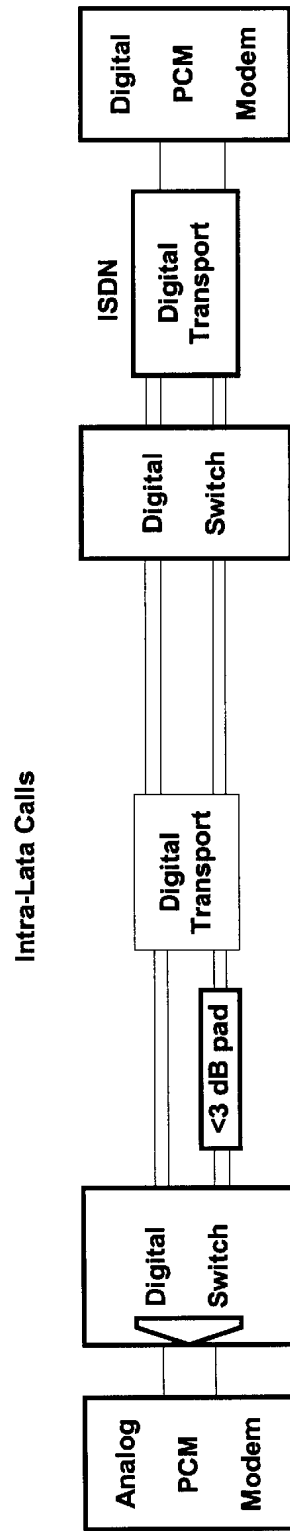

Figure 2E Prior Art

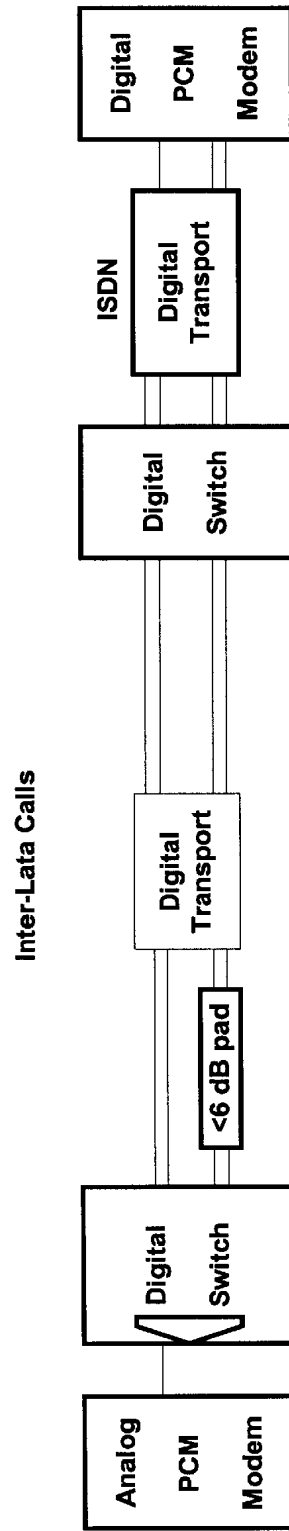

Figure 2F Prior Art

U/Law	Segment	Step	Sign	Exponent	Magnitude	Linear	Decision	Average	6 dB pad	PCM	Error	Duplicate	3 dB pad	PCM	Error	Duplicate
255	15	15	1	1	0	0	0	0	0	0	0	0	0	0	0	0
254	15	14	1	1	2	0	1	2	1.00237	0	-0.99763	0	1.41589	2	-0.58411	1
253	15	13	1	1	4	2	3	4	2.00475	2	0.00475	0	2.83178	2	0.83178	0
252	15	12	1	1	3	6	5	6	3.00712	4	-0.99288	1	4.24767	4	0.24767	0
251	15	11	1	1	4	8	7	8	4.0095	4	0.0095	0	5.66357	6	-0.33643	0
250	15	10	1	1	10	10	9	10	5.01187	6	-0.98813	1	7.07946	8	-0.92054	1
249	15	9	1	1	6	12	11	12	6.01425	6	0.01425	0	8.49535	8	0.49535	0
248	15	8	1	1	7	14	15	16	7.01662	8	-0.98338	1	9.91124	10	-0.08876	0
247	15	7	1	1	8	16	17	18	8.019	8	0.019	0	11.3271	12	-0.67287	1
246	15	6	1	1	9	18	19	20	9.02137	10	-0.97863	1	12.743	12	0.74302	0
245	15	5	1	1	10	20	21	22	10.0237	10	0.02374	0	14.1589	14	0.15892	0
244	15	4	1	1	11	22	23	24	11.0261	12	-0.97388	1	15.5748	16	-0.42519	1
243	15	3	1	1	12	24	25	26	12.0285	12	0.02849	0	16.9907	16	0.9907	0
242	15	2	1	1	13	26	27	28	13.0309	14	-0.96913	1	18.4066	18	0.40659	0
241	15	1	1	1	14	28	29	30	14.0332	14	0.03324	0	19.8225	20	-0.17752	0
240	15	0	1	1	15	30	31	33	15.0356	16	-0.96438	1	21.2384	22	-0.76163	0
239	14	15	1	2	0	33	35	37	16.5392	18	0.53918	0	23.3622	24	-0.63779	0
238	14	14	1	2	1	37	39	41	18.5439	18	0.54393	0	26.194	26	0.19399	0
237	14	13	1	2	2	41	43	45	20.5487	20	0.54868	0	29.0258	30	-0.97422	0
236	14	12	1	2	3	45	47	49	22.5534	22	0.55343	0	31.8576	33	-1.14244	1
235	14	11	1	2	4	49	51	53	24.5582	24	0.55817	0	34.6893	33	1.68934	0
234	14	10	1	2	5	53	55	57	26.5629	26	0.56292	0	37.5211	37	0.52113	0
233	14	9	1	2	6	57	59	61	28.5677	28	0.56767	0	40.3529	41	-0.64709	0
232	14	8	1	2	7	61	63	65	30.5724	30	0.57242	0	43.1847	45	-1.81531	1
231	14	7	1	2	8	65	67	69	32.5772	33	-0.42283	1	46.0165	45	1.01648	0
230	14	6	1	2	9	69	71	73	34.5819	33	1.58192	0	48.8483	49	-0.15174	0
229	14	5	1	2	10	73	75	77	36.5867	37	-0.41333	1	51.68	53	-1.31996	1
228	14	4	1	2	11	77	79	81	38.5914	37	1.59142	0	54.5118	53	1.51183	0
227	14	3	1	2	12	81	83	85	40.5962	41	-0.40383	1	57.3436	57	0.34361	0
226	14	2	1	2	13	85	87	89	42.6009	41	1.60091	0	60.1754	61	-0.82461	0
225	14	1	1	2	14	89	91	93	44.6057	45	-0.39434	1	63.0072	65	-1.99283	1
224	14	0	1	2	15	93	95	99	46.6104	45	1.61041	0	65.839	65	0.83896	0
223	13	15	1	3	0	99	103	107	49.6175	49	0.61754	0	70.0866	69	1.08663	0
222	13	14	1	3	1	107	111	115	53.627	53	0.62703	0	75.7502	77	-1.2498	0
221	13	13	1	3	2	115	119	123	57.6365	57	0.63653	0	81.4138	81	0.41377	0
220	13	12	1	3	3	123	127	131	61.646	61	0.64603	0	87.0773	89	-1.92267	0
219	13	11	1	3	4	131	135	139	65.6555	65	0.65553	0	92.7409	93	-0.2591	0
218	13	10	1	3	5	139	143	147	69.665	69	0.66503	0	98.4045	99	-0.59554	0
217	13	9	1	3	6	147	151	155	73.6745	73	0.67452	0	104.068	107	-2.93197	1
216	13	8	1	3	7	155	159	163	77.684	77	0.68402	0	109.732	107	2.7316	0
215	13	7	1	3	8	163	167	171	81.6935	81	0.69352	0	115.395	115	0.39516	0
214	13	6	1	3	9	171	175	179	85.703	85	0.70302	0	121.059	123	-1.94127	1
213	13	5	1	3	10	179	183	187	89.7125	89	0.71251	0	126.722	123	3.7223	0

Figure 3a

212	13	4	1	3	11	187	191	195	93.722	93	0.72201	0	132.386	131	1.38586	0
211	13	3	1	3	12	195	199	203	97.7315	99	-1.26849	0	138.049	139	-0.95057	0
210	13	2	1	3	13	203	207	211	101.741	99	2.74101	0	143.713	147	-3.28701	1
209	13	1	1	3	14	211	215	219	105.751	107	-1.24949	1	149.377	147	2.37656	0
208	13	0	1	3	15	219	223	231	109.76	107	2.76	0	155.04	155	0.04013	0
207	12	15	1	4	0	231	239	247	115.774	115	0.77425	0	163.535	163	0.53548	0
206	12	14	1	4	1	247	255	263	123.793	123	0.79325	0	174.863	171	3.86261	0
205	12	13	1	4	2	263	271	279	131.812	131	0.81224	0	186.19	187	-0.81026	0
204	12	12	1	4	3	279	287	295	139.831	139	0.83124	0	197.517	195	2.51687	0
203	12	11	1	4	4	295	303	311	147.85	147	0.85023	0	208.844	211	-2.15599	0
202	12	10	1	4	5	311	319	327	155.869	155	0.86923	0	220.171	219	1.17114	0
201	12	9	1	4	6	327	335	343	163.888	163	0.88823	0	231.498	231	0.49827	0
200	12	8	1	4	7	343	351	359	171.907	171	0.90722	0	242.825	247	-4.1746	1
199	12	7	1	4	8	359	367	375	179.926	179	0.92622	0	254.153	247	7.15254	0
198	12	6	1	4	9	375	383	391	187.945	187	0.94521	0	265.48	263	2.47967	0
197	12	5	1	4	10	391	399	407	195.964	195	0.96421	0	276.807	279	-2.1932	0
196	12	4	1	4	11	407	415	423	203.963	203	0.9832	0	288.134	295	-6.86607	1
195	12	3	1	4	12	423	431	439	212.002	211	1.0022	0	299.461	295	4.46107	0
194	12	2	1	4	13	439	447	455	220.021	219	1.0212	0	310.788	311	-0.2118	0
193	12	1	1	4	14	455	463	471	228.04	231	-2.95981	1	322.115	327	-4.88467	1
192	12	0	1	4	15	471	479	495	236.059	231	5.05919	0	333.442	327	6.44246	0
191	11	15	1	5	0	495	511	527	248.088	247	1.08788	0	350.433	343	7.43316	0
190	11	14	1	5	1	527	543	559	264.126	263	1.12567	0	373.087	375	-1.91257	0
189	11	13	1	5	2	559	575	591	280.164	279	1.16366	0	395.742	391	4.74169	0
188	11	12	1	5	3	591	607	623	296.202	295	1.20166	0	418.396	423	-4.60404	0
187	11	11	1	5	4	623	639	655	312.24	311	1.23985	0	441.05	439	2.05022	0
186	11	10	1	5	5	655	671	687	328.278	327	1.27764	0	463.704	471	-7.29551	0
185	11	9	1	5	6	687	703	719	344.316	343	1.31563	0	486.359	495	-8.64125	1
184	11	8	1	5	7	719	735	751	360.354	359	1.35362	0	509.013	495	14.013	0
183	11	7	1	5	8	735	767	783	376.392	375	1.39161	0	531.667	527	4.66728	0
182	11	6	1	5	9	767	799	815	392.43	391	1.4296	0	554.322	559	-4.67845	0
181	11	5	1	5	10	815	831	847	408.468	407	1.4676	0	576.976	591	-14.0242	1
180	11	4	1	5	11	847	863	879	424.506	423	1.50559	0	599.63	591	8.63008	0
179	11	3	1	5	12	879	895	911	440.544	439	1.54358	0	622.284	623	-0.71566	0
178	11	2	1	5	13	911	927	943	456.582	455	1.58157	0	644.939	655	-10.0614	1
177	11	1	1	5	14	943	959	975	472.62	471	1.61956	0	667.593	655	12.5929	0
176	11	0	1	5	15	975	991	1023	488.658	495	-6.34245	0	690.247	687	3.24714	0
175	10	15	1	6	0	1023	1055	1087	512.715	527	-14.2855	0	724.229	719	5.22854	0
174	10	14	1	6	1	1087	1119	1151	544.791	559	-14.2095	0	769.537	783	-13.4629	0
173	10	13	1	6	2	1151	1183	1215	576.867	591	-14.1335	0	814.846	815	-0.1544	0
172	10	12	1	6	3	1215	1247	1279	608.942	623	-14.0575	0	860.154	847	13.1541	0
171	10	11	1	6	4	1279	1311	1343	641.018	655	-13.9815	0	905.463	911	-5.53734	0
170	10	10	1	6	5	1343	1375	1407	673.094	687	-13.9056	0	950.771	943	7.77119	0
169	10	9	1	6	6	1407	1439	1471	705.17	719	-13.8296	0	996.08	1023	-26.9203	1
168	10	8	1	6	7	1471	1503	1535	737.246	751	-13.7536	0	1041.39	1023	18.3882	0
167	10	7	1	6	8	1535	1567	1599	769.322	783	-13.6776	0	1086.7	1087	-0.30322	0
166	10	6	1	6	9	1599	1631	1663	801.398	815	-13.6016	0	1132.01	1151	-18.9947	1

Figure 3b

165	10	5	1	6	10	1663	1695	1727	833.474	847	-13.5256	0	1177.31	1151	26.3138	0
164	10	4	1	6	1727	1791	1759	1791	865.55	879	-13.4496	0	1222.62	1215	7.62237	0
163	10	3	1	6	1791	1855	1823	1855	897.626	911	-13.3737	0	1267.93	1279	-11.0691	0
162	10	2	1	6	1855	1919	1887	1919	929.702	943	-13.2977	0	1313.24	1343	-29.7606	1
161	10	1	1	6	1919	1983	1951	1983	961.778	975	-13.2217	0	1358.55	1343	15.548	0
160	10	0	1	6	1983	2015	2015	2079	993.854	1023	-29.1457	1	1403.86	1407	-3.14351	0
159	9	15	1	7	2079	2143	2143	2207	1041.97	1023	18.9683	0	1471.82	1471	0.81929	0
158	9	14	1	7	2207	2271	2271	2335	1106.12	1087	19.1202	0	1562.44	1536	27.4363	0
157	9	13	1	7	2335	2399	2399	2463	1170.27	1151	19.2722	0	1653.05	1663	-9.94659	0
156	9	12	1	7	2463	2527	2527	2591	1234.42	1215	19.4242	0	1743.67	1727	16.6705	0
155	9	11	1	7	2591	2655	2655	2719	1298.58	1279	19.5761	0	1834.29	1855	-20.7125	0
154	9	10	1	7	2719	2783	2783	2847	1362.73	1343	19.7281	0	1924.9	1919	5.90459	0
153	9	9	1	7	2847	2911	2911	2975	1426.88	1407	19.8801	0	2015.52	2079	-63.4784	1
152	9	8	1	7	2975	3039	3039	3103	1491.03	1471	20.032	0	2106.14	2079	27.1387	0
151	9	7	1	7	3103	3167	3167	3231	1555.18	1535	20.184	0	2196.76	2207	-10.2442	0
150	9	6	1	7	3231	3295	3295	3359	1619.34	1599	20.336	0	2287.37	2335	-47.6272	1
149	9	5	1	7	3359	3423	3423	3487	1683.49	1663	20.4879	0	2377.99	2335	42.9899	0
148	9	4	1	7	3487	3551	3551	3615	1747.64	1727	20.6399	0	2468.61	2463	5.60695	0
147	9	3	1	7	3615	3679	3679	3743	1811.79	1791	20.7918	0	2559.22	2591	-31.776	1
146	9	2	1	7	3743	3807	3807	3871	1875.94	1855	20.9438	0	2649.84	2591	58.8411	0
145	9	1	1	7	3871	3935	3935	3999	1940.1	1919	21.0958	0	2740.46	2719	21.4581	0
144	9	0	1	7	3999	4063	4063	4191	2004.25	1983	21.2477	0	2831.08	2847	-15.9248	0
143	8	15	1	8	4191	4319	4319	4447	2100.48	2079	21.4757	0	2967	2975	-7.99922	0
142	8	14	1	8	4447	4575	4575	4703	2228.78	2207	21.7796	0	3148.23	3103	45.2349	0
141	8	13	1	8	4703	4831	4831	4959	2357.08	2335	22.0836	0	3329.47	3359	-29.531	0
140	8	12	1	8	4959	5087	5087	5215	2485.39	2463	22.3875	0	3510.7	3487	23.7031	0
139	8	11	1	8	5215	5343	5343	5471	2613.69	2591	22.6914	0	3691.94	3743	-51.0627	0
138	8	10	1	8	5471	5599	5599	5727	2742	2719	22.9954	0	3873.17	3871	2.17139	0
137	8	9	1	8	5727	5855	5855	5983	2870.3	2847	23.2993	0	4054.41	3999	56.4055	0
136	8	8	1	8	5983	6111	6111	6239	2998.6	2975	23.6032	0	4235.64	4191	44.6396	0
135	8	7	1	8	6239	6367	6367	6495	3126.91	3103	23.9072	0	4416.87	4447	-30.1263	0
134	8	6	1	8	6495	6623	6623	6751	3255.21	3231	24.2111	0	4598.11	4703	-104.892	1
133	8	5	1	8	6751	6879	6879	7007	3383.52	3359	24.515	0	4779.34	4703	76.342	0
132	8	4	1	8	7007	7135	7135	7263	3511.82	3487	24.8189	0	4960.58	4959	1.57611	0
131	8	3	1	8	7263	7391	7391	7519	3640.12	3615	25.1229	0	5141.81	5215	-73.1898	1
130	8	2	1	8	7519	7647	7647	7775	3768.43	3743	25.4268	0	5323.04	5215	108.044	0
129	8	1	1	8	7775	7903	7903	8031	3896.73	3871	25.7307	0	5504.28	5471	33.2785	0
128	8	0	1	8	8031	8159	8159	4079.5	4025.03	3999	26.0347	0	5685.51	5727	-41.4874	0

25

16

Figure 3c

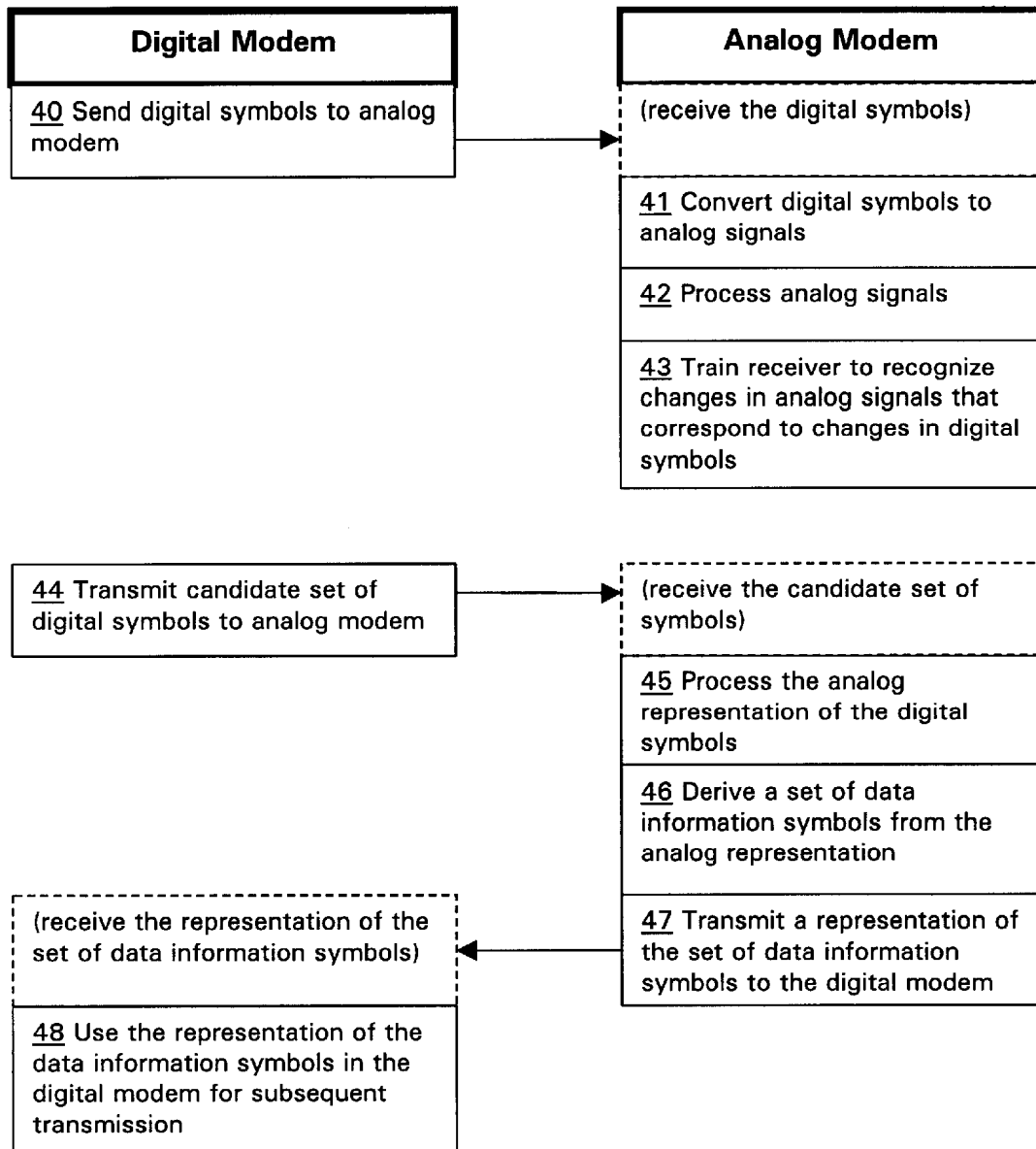

Figure 4

DETECTION AND ADAPTATION TO DIGITAL NETWORK IMPAIRMENTS BY PCM MODEMS

This application claims benefit of Prov. No. 60/038,570 filed Mar. 3, 1997.

FIELD OF THE INVENTION

The invention relates to modem technology, more particularly to PCM modem technology, and more particularly to a method for detecting and adapting to digital network impairments in a PCM modem.

BACKGROUND OF THE INVENTION

PCM modem technology as proposed requires no changes need to be made in the existing telecommunications system. Much attention has been paid to impairments affecting the local analog loop. However, there are several known digital impairments which can equally affect the performance of the PCM modems. The known impairments are the following:

- a) Digital attenuation pads (3 dB and 6 dB)
- b) Robbed bit signaling
- c) PCM sample slips
- d) PCM code conversions

It would be impractical to require the telephone carriers to change their transmission facilities. These digital impairments can and should be accommodated by PCM modems. Each of the above-identified impairments is further discussed below.

Digital Attenuation Pads

The network model diagrams for evaluation of PCM modems described in Sierra Semiconductor, "Liaison to TR30.1 Concerning PCM Modems," Ft. Lauderdale, Jan. 23-24, 1997, Doc. FL-08, and Intel, "Proposed Provisional PCM Modem Network Model," Ft.

Lauderdale, Jan. 23-24, 1997, Doc. FL-02, show configurations with 3 and 6 dB pads within the digital transport/switching network. FIG. 1 presents the network model of the Intel paper, which illustrates the two-wire analog to four-wire digital PCM interface. Included in the interface are the A/D and DIA converters that process input and output of the PCM modem, analog attenuation elements including IMD and RTDIAD/EDD elements, noise generators summed with transmitted signals and a balance network interface. G.121 further identifies additional attenuation pads used by various countries outside of North America. These pads are implemented via digital circuits or ROMs which provide a systematic remapping of PCM codes to other PCM codes. This mapping to a new space in the digital network is invariant for a telephone connection.

Conventional PCM modem technology relies on the network being digital with a single DIA converter in the path between the digital modem and the analog modem. During training, PCM modems will determine whether the channel can support the technology. If the network connection cannot support the PCM mode (i.e. offer a higher data rate than can be achieved with V.34), the modems will either fall back to another mode (e.g. V.34) or disconnect. However, there are a variety of different network configurations having differing digital attenuation elements. FIGS. 2a-2f illustrate various existing network configurations deployed between an analog PCM modem and a digital PCM modem. It is seen by comparison of these figures that a variety of configurations involving various combinations of digital switches, digital transport, and 3 dB and 6 dB attenuation pads are possible.

Accordingly, since significant variation exists in the implementation of attenuation pads, static predetermination

of all possible remappings of PCM codes to other PCM codes is not viable.

Robbed Bit Signaling

Robbed bit signaling is used on North American telephone trunks for interoffice signaling. The least significant bit of every sixth PCM sample is used for signaling. Within the telephone network from end-to-end, typically two PCM samples within every six may be used for signaling, although in the worst case it may be all six. The effect of this impairment is the inability to convey information in this bit position. It further may affect PCM code transformations due to attenuation pads or law conversions.

PCM Sample Slips

PCM sample slips occur for purposes of synchronization within the telephone network or between telephone networks. Either a PCM sample is completely dropped or repeated. Detection of such impairments relies on redundancy or trellis coding or forward error correction of some form.

PCM Code Conversions

PCM code conversions between u-law and A-law occur over international calls. This is a systematic mapping of codes from one law to the other. This mapping is not exactly one to-one according to the recommendations in G.711.

Regulatory Analog Transmission Power Limits

In addition to the digital impairments, telecommunications regulatory agencies have established power limits for circuits which terminate in an analog local loop, see Communications Certification Laboratory, "Liaison to T1A1.7 and TR30.1 on FCC Part 68 Compliance for PCM Modems," Ft. Lauderdale, Jan. 23-24, 1997, Doc. FL-10. This limitation is a result of real implementation restrictions already within the deployed telephone equipment.

The highest data rates in the downstream direction (from the digital to the analog modem) can only be achieved if all of the μ -law encoded levels can be used. However, the average energy of a sequence that uses all 255 μ -law levels with equal probability is well above the maximum permitted transmit power level of -12 dBm0 specified in FCC part 68.

Thus it is apparent that the need to comply with this limitation requires use of a subset of the available PCM codes in the set of PCM symbols to be used for the high speed data transmission. Non-equally probably mappings (i.e. shell mapping) could be used to alter and control the probability distribution of each of the PCM codes in the set of symbols. Even with non-equally probably mapping techniques, the analysis in RSA Communications, " μ -law signal power," Orlando, Dec. 4, 1996, Doc. Orlando-10R#, suggests that both the highest and lowest segments of the μ -law codes would not be used. The highest segments are eliminated because of signal power limits. The lowest are eliminated to increase the minimum distance between signal values.

SUMMARY OF THE INVENTION

The invention provides a means of detecting the presence of attenuation pads (3 dB or 6 dB) in the analog PCM modem, a determination of an appropriate set of PCM symbols for greatest data rates and communication of the attenuation and/or the selected set of PCM symbols to the digital modem. Without selection of alternate sets of PCM symbols, the data rate would be reduced and/or more problematic to receive without error when digital attenuation is present. The techniques of the invention eliminate the need for uniqueness in mapping for successful interoperability of L-law and A-law codes. Accordingly, the invention may be embodied in a method of compensating for systemic impairments in a telecommunications network. The method may involve transmitting a candidate set of digital symbols from a digital modem to an analog modem, processing an analog

representation of said candidate set of digital symbols in the analog modem, deriving a set of data information symbols from the analog representation of the candidate set of digital symbols, transmitting a representation of the data information symbols from the said analog modem to the digital modem, and using the representation of the data information symbols in digital modem for subsequent transmission of data from the digital modem. The method may also include the preceding steps of sending digital symbols from the digital modem to the analog modem, converting the digital symbols into analog signals in the telephone network, processing the analog signals in the analog modem, and training a receiver of the analog modem to recognize changes in the analog signals that correspond to known changes in digital symbols transmitted by the digital modem.

DESCRIPTION OF THE DRAWINGS

FIG. 1 shows a model of a two-wire analog to four-wire digital PCM interface;

FIGS. 2a-2f show various existing network configurations deployed between an analog PCM modem and a digital PCM modem;

FIGS. 3a-3c show a table of μ -law values 255-128 and their corresponding PCM values after attenuation by 6 dB and 3 dB pads; and

FIG. 4 illustrates a method in a telecommunications network for compensating for systemic impairments.

DETAILED DESCRIPTION OF THE PREFERRED EMBODIMENT

Detection of Digital Impairments

PCM modems are sensitive to timing slips in two phases of its operation: training and steady state. If they occur during training they will corrupt the training process and training has to be reinitiated. Mechanisms that provide for fast recovery of training failure due to timing slips is required. PCM timing slips that occur during steady state require a resynchronization of the data stream. While detection and resynchronization may be accomplished solely by the receiver, this is problematic and complicated when trellis decoding is used. Use of two different forms of renegotiation though would provide both seamless without resynchronization and "seamed" with resynchronization. The "seamed" would only be used when PCM sample resynchronization is required. A PCM sample slip will also affect some of the other digital impairments, mainly robbed bit signaling, which will need to be re-determined.

For the detection of the other digital impairments, a training sequence at the end of Phase 3 in a preferred embodiment uses all PCM magnitude values in a mid-band frequency. Several sequences exist which will produce all valid PCM codes and whose energy content is concentrated in the center of the receive band. This sequence should be able to be received with great reliability. Use of such a sequence would allow detection of the digital network impairments.

Prior to receiving this portion of the training sequence, the analog PCM modem must have its equalizer trained and have an estimate of the S/N (without its echo canceller in operation) in the analog local loop. For all PCM magnitudes received as part of the training sequence, the receiver can then determine all PCM codes which can be uniquely received and sets of PCM codes which are indistinguishable for its observed S/N. PCM codes can be indistinguishable due to attenuation pads, robbed bit signaling and law conversions.

FIGS. 3a-3c show a table of μ -law values 255-128 and their corresponding PCM values after attenuation by 6 dB and 3 dB pads. It is seen in the table that certain μ -law values produce identical PCM values, and hence cannot be used to

transmit unique information through the network. By excluding μ -law values that produce duplicates, a set of unique μ -law values for the network conditions is realized.

In a preferred embodiment, the training sequence may be repeated, shifted by successive numbers of samples (1 to 5), in order to uniquely identify bit positions used for robbed bit signaling. This would allow the analog modem to make a determination of the precise set of systematic PCM code mappings which are uniquely received for each of the six bit positions.

In practice, the approach of repeating for each of the possible robbed bit positions may require transmission of a fairly lengthy sequence approaching 100 msec in duration. This can be avoided if the convention first assumes that the LSB of every PCM code is corrupted. Then once the digital modem reaches steady state, the digital PCM modem produces some known synchronizing pattern in all of the LSB's. The analog PCM modem would attempt to detect the synchronizing pattern and once detected, it could signal to the digital PCM modem via a seamless rate change the usability of the particular LSB(s) for carrying data. This mechanism would also significantly aid recovery from PCM sample slip as described earlier.

Analysis of Detection Results

Once the analog modem has determined all PCM codes which can be uniquely received and all sets of indistinguishable systematic PCM code mappings due to attenuation pads, robbed bit signaling and law conversions, some or all of this information can be conveyed to the digital PCM modem. The digital PCM modem would then be able to avoid the indistinguishable codes (or least not use different codes within the set of indistinguishable codes for conveying different information bits) and the robbed bits.

By analyzing the sets of indistinguishable PCM codes, it is possible to determine the digital telephone network attenuation. For example, Hayes Microcomputer Products, Inc., "Digital Trunk Loss," Ft. Lauderdale, Jan. 23-24, 1997, Doc. FL-07, shows a set of 32 PCM codes for 16 sets of indistinguishable codes after mapping through a 6.0206 dB attenuation pad. For a 3 dB attenuation pad, 25 sets of indistinguishable codes result after mapping. These sets of indistinguishable PCM codes, and even just a subset of these sets, can thus be an unambiguous characteristic of the 3 and 6 dB digital attenuation pads in the telephone network. A subset for either the 6 or 3 dB pads would consist of checking the indistinguishable codes corresponding to some arbitrary number of the larger characteristic indistinguishable PCM codes.

Additional analysis of the lowest level indistinguishable PCM codes will reveal those which are below the real or expected noise floor of the receiver. The receiver's estimate of S/N and knowledge of the noise contributed by its AFE and local echo canceller can be used to establish a threshold below which received PCM codes cannot be distinguished. This could then be used to restrict usage of such PCM codes in the data transfer from the digital PCM modem to the analog PCM modem.

Thus, the invention may be embodied in a method in a telecommunications network for compensating for systemic impairments. FIG. 4 illustrates this method. The method may include a conventional training sequence that includes sending 40 digital symbols from a digital modem to an analog modem, converting 41 the digital symbols into analog signals in the telephone network, processing 42 the analog signals in the analog modem, and training 43 a receiver of the analog modem to recognize changes in the analog signals that correspond to known changes in the digital symbols transmitted by the digital modem. Systemic impairments are then compensated by transmitting 44 a candidate set of digital symbols from said digital modem to said analog modem, processing 45 an analog representation

5

of said candidate set of digital symbols by said analog modem, deriving 46 a set of data information symbols from said analog representation of said candidate set of digital symbols, transmitting 47 a representation of said data information symbols from said analog modem to said digital modem, and using 48 said representation of said data information symbols by said digital modem for subsequent transmission of data from said digital modem

Adaptation to Digital Network Attenuation

In a simple implementation, there can be three predetermined sets of PCM symbols. One for 0 dB attenuation, one for 3 dB attenuation and one for 6 dB attenuation. All of the sets of PCM symbols would have been predetermined to meet the FCC power limitations with no attenuation, 3 dB attenuation or 6 dB attenuation. Further some PCM codes could be reserved as substitutes in case some sets of additional PCM codes are indistinguishable.

Alternatively, the mapping technique (i.e. shell mapping) used for selecting codes within the predetermined PCM symbol set can apply a different distributions in the case of 0 dB, 3 dB or 6 dB attenuation. Again the power limitations can be met for the analog local loop.

The determination of the adaptation to apply can be done by either both analog and digital PCM modems, or can be performed by one modem and communicated to the other. For simplification, in a preferred embodiment the analog PCM modem may determine the adaptation to be applied and communicate this to the digital PCM modem along with any other significant indistinguishable PCM codes and robbed bit position(s).

Once the digital PCM modem starts the high speed data transfer, the selected set of PCM symbols and mapper distribution would reliably be remapped to a set of PCM values that a) meet the FCC power limitations at the analog local loop, and b) can be received by the analog PCM modem and unmapped to the symbols or bit stream originally encoded by the digital PCM modem.

The transfer of downstream data would occur at higher bit rates than if a single set of PCM values and single mapper distribution was used without any compensation for the digital network attenuation.

The method described above may be employed in a PCM modem to determine and adapt to various digital network impairments which are crucial for optimal PCM modem operation.

Specifically, this procedure provides a mechanism for detecting the digital network attenuation and selection of a set of PCM symbols and/or a different mapping distribution to compensate for the detected digital network attenuation. As a result of the systematic mapping within the digital network, this adaptation can reliably honor the FCC power limitations and can provide for the highest rates of throughput irrespective of the digital network attenuation. It is preferred that this approach be adopted in the TIA standard. The incorporation of this technique into the standard will be very straightforward and allow for greater network coverage [approximately of an additional 60%] of at higher data rates than would be possible with no such adjustment [approximately 25%].

What we claim is:

1. A method of compensating for systemic impairments in a, telecommunications network, comprising:

transmitting a candidate set of digital symbols from a digital mode into an analog modem;

processing an analog representation of said candidate set of digital symbols by said analog modem;

deriving a set of data information symbols from said analog representation of said candidate set of digital

6

symbols, the set of data information symbols consisting of digital symbols that can be uniquely received by the analog modem;

transmitting a representation of said data information symbols from said analog modem to said digital modem; and,

using said representation of said data information symbols by said digital modem for subsequent transmission of data from said digital modem.

2. A method of compensating for systemic impairments in a telecommunications network, comprising:

sending digital symbols from a digital modem to an analog modem;

converting said digital symbols into analog signals;

processing said analog signals by an analog modem;

training a receiver of said analog modem to recognize changes in said analog signals that correspond to known changes in digital symbols transmitted by the digital modem;

transmitting a candidate set of digital symbols from said digital [model] modem to said analog modem;

processing an analog representation of said candidate set of digital symbols by said analog modem;

deriving a set of data information symbols from said analog representation of said candidate set of digital symbols, the set of data information symbols consisting of digital symbols that can be uniquely received by the analog modem;

transmitting a representation of said data information symbols from said analog modem to said digital modem; and,

using said representation of said data information symbols by said digital modem for subsequent transmission of data from said digital modem.

3. A method of communication in a digital modem, comprising:

transmitting a candidate set of digital symbols to an analog modem through a telecommunications network;

receiving a representation of a set of data information symbols from the analog modem, the set of data information symbols consisting of digital symbols of the candidate set that can be uniquely received by the analog modem through the network; and

using the set of data information symbols for subsequent transmission of data to the analog modem.

4. A method of communication in an analog modem, comprising:

receiving a candidate set of digital symbols from a digital modem through a telecommunications network;

processing an analog representation of the candidate set of digital symbols;

deriving a set of data information symbols from the analog representation of the candidate set of digital symbols, the set of data information symbols consisting of digital symbols that can be uniquely received by the analog modem through the network; and

transmitting a representation of the set of data information symbols to the digital modem.

UNITED STATES PATENT AND TRADEMARK OFFICE
CERTIFICATE OF CORRECTION

PATENT NO. : 6,327,301 B1
DATED : December 4, 2001
INVENTOR(S) : Victor Demjanenko, Frederic J. Hirzel

Page 1 of 1

It is certified that error appears in the above-identified patent and that said Letters Patent is hereby corrected as shown below:

Column 1,

Row 41, "DIA" should read, -- D/A --

Row 42, "modern" should read, -- modem --

Row 43, "RTDIAD/EDD" should read, -- RTD/AD/EDD --

Row 52, "DIA" should read, -- D/A --

Column 2,

Row 63, "L-Law" should read, -- μ -Law --

Column 5,

Row 61, "mode into" should read, -- modem to --

Column 6,

Row 24, "[model]" should be deleted

Signed and Sealed this

Ninth Day of April, 2002

Attest:



Attesting Officer

JAMES E. ROGAN
Director of the United States Patent and Trademark Office